

urban goods transport; urban rail distribution; transport service model; urban mode choice

Antonio COMI*, Agostino NUZZOLO

Tor Vergata University of Rome
via del Politecnico 1, 00133, Rome, Italy

*Corresponding author. E-mail: comi@ing.uniroma2.it

MODELLING CHALLENGES TO FORECAST URBAN GOODS DEMAND FOR RAIL

Summary. This paper explores the new research challenges for forecasting urban goods demand by rail. In fact, the growing interest to find urban logistics solutions for improving city sustainability and liveability, mainly due to the reduction of urban road accessibility and environmental constraints, has pushed to explore solutions alternative to the road. Multimodal urban logistics, based on the use of railway, seem an interesting alternative solution, but it remained mainly at conceptual level. Few studies have explored the factors, that push actors to find competitive such a system with respect to the road, and modelling framework for forecasting the relative demand. Therefore, paper reviews the current literature, investigates the factors involved in choosing such a mode, and finally, recalls a recent modelling framework and hence proposes some advancements that allow to point out the rail transport alternative.

MODELOWANIE PROGNOZOWANIA TRANSPORTU DÓBR W MIASTACH Z WYKORZYSTANIEM KOLEI

Streszczenie. Artykuł analizuje nowe wyzwania badawcze związane z prognozowaniem transportu dóbr w miastach z wykorzystaniem kolei. Rosnące zainteresowanie znalezieniem logistycznych rozwiązań miejskich, które miałyby poprawić zrównoważony rozwój miasta oraz zwiększyć jakość życia mieszkańców, spowodowane jest zmniejszeniem dostępności do dróg miejskich oraz ograniczeniami środowiskowymi. Wspomniane aspekty wymogły rozpoczęcie badań nad innymi rozwiązaniami niż wykorzystanie dróg. Multimodalne rozwiązania logistyki miejskiej, oparte na wykorzystaniu kolei, wydają się być interesującym rozwiązaniem alternatywnym, jednak pozostają głównie tylko na poziomie koncepcji. W badaniach analizowano czynniki, które skłaniały do odnalezienia konkurencyjnego dla drogi systemu i ramy modelowania dla prognozowania rzeczywistego popytu. W artykule zaprezentowano ocenę bieżącej literatury, badanie czynników wpływających na wybór kolei oraz przypomniano niedawne ramy modelowania. W pracy zaproponowano również nowe rozwiązania, które pozwalają na wskazanie transportu kolejowego jako alternatywy do transportu drogowego.

1. INTRODUCTION

In recent years, in order to meet the new challenges for improving city sustainability and liveability, several city logistics solutions have been proposed and implemented around the world (Browne et al. [8], Russo and Comi [44], Taniguchi and Thompson [47]). In this context, local administrators mainly

managed operational actions in order to reduce interferences with other vehicles and inhabitants (e.g. using Limited Freight Traffic Zones) and the pollutant emissions (e.g. using constraints based on Euro emission standards and new urban distribution centres and electric vehicles). Recently, local administrators are also looking at rail transport as an environmentally friendly transport mode (e.g. cargo trams and trains). Most of such experiences were made in particular areas and time periods, e.g. transportation of some typologies of goods by tram, to satisfy some logistic needs of private firms (Beherends [5], Bestufs [7], Lange [25], van Binsbergen and Visser [49]) or for outlet restocking in a congested urban area in which a railway network already exists (Genta et al. [19], Nuzzolo et al. [38], Robinson and Mortimer [41, 42]). Dizian et al. [18] investigated such city logistics solution comparing the experiences made in Japan and France, trying to identify the opportunities for knowledge transfer of best practices for promotion of modal shift and for land use and planning policies that favour rail-based urban goods. For example, Kawasaki City started the transport of waste material using railways in 1995. The service uses main urban railways (including stations) with a covered distance of 23 km. Its success was mainly due to the use of existing railways infrastructures, to subsidies from the Ministry of Environment for the initial investment and Japan Railway Freight Company was eager to increase activities in its freight stations.

In latest years, these initiatives are on fashion both for the reduction of road accessibility of metropolitan areas for congestion effects, and the implementation of some environmental measures, despite the difficulties of rail transport to be competitive with respect to road transport (Alessandrini et al. [1], Browne et al. [9], Marinov et al. [28], Mortimer [31], Motraghi and Marinov [32], Wiegman et al. [50]). However, the methods and models for investigating the competitiveness of a goods distribution based on railway services is quite limited. The main studies have been addressed to identify the opportunities given by such a system and the results obtained or obtainable from its implementation, basing the analysis on empirical data (Table 1). Besides, some papers focus on the functional definition of the system and using empirical demand forecasts, proposed Cost-Benefit Analysis (Gonzalez-Feliu [20] and De Langhe [17]), missing to investigate the main factors that could push actors to find rail service as a competitive alternative to road.

Table 1

Synoptic overview of studies on railway urban transport and logistics

Criteria	Demand		Supply		Assessment	
	<i>by model</i>	<i>empirical</i>	<i>definition</i>	<i>performance</i>	<i>ex-ante</i>	<i>ex-post</i>
Alessandri et al. [1]		x	x			
Browne et al. [9]			x	x	x	
Genta et al. [19]			x			
De Langhe [17]		x	x		x	
Dizian et al. [18]		x	x	x		
Gonzalez-Feliu [20]		x	x	x	x	
Lange [25]		x	x		x	
Marinov et al. [28]		x	x			
Motraghi and Marinov [32]		x	x		x	
Nuzzolo et al. [38]	x		x	x	x	x
Robinson and Mortimer [41, 42]			x	x		
Sladkowski et al. [46]		x	x	x	x	
Wiegman et al. [50]		x	x	x		

As it emerges from Table 1, due to limited literature on *ex-post* experiences, project evaluation and effect assessment of new urban rail service systems has to be mainly based on the simulations of future scenarios (using a “what if approach”), computing some effect indicators able to quantify the expected results in terms of internal and external, direct and indirect costs (Browne et al., [8], Nuzzolo and Comi, [33]). Generally, these indicators are obtained from the network performances and impacts forecasted

using a transport simulation system consisting of different sub-systems: road and rail network, demand, assignment, and performance (impacts).

The *network sub-system* comprises the graph of the main road and rail network, and relative link cost functions. The *demand sub-system* simulates the relevant aspects of travel demand as a function of the activity system and road/rail travel costs. As pictured in Fig. 1, the demand models have to provide as outputs the O-D matrices that assigned to the transport network (both road and road-rail) give us the link flows for project/scenario evaluation and effect assessment.

The *assignment* sub-system includes path choice and network loading models. The network loading model simulates how O-D vehicle flows load the paths, and the links of the road and rail network, and estimates the link flows. These flows are in turn used as inputs of the other models that, for example, allow determination of pollution emissions, energy consumption, road accidents and so on (*performance sub-system*).

It has to be noted that different demand models have to be used for O-D matrix estimation according to possible different temporal scales: strategic, tactical and operational. Referring to goods rail distribution system, if new infrastructures have to be built (strategic long term actions), the models have to consider that the demand of goods within urban areas can change along the time. In fact, as emerged by several surveys (Nuzzolo et al. [37]), the urban areas are mainly attractors of goods due to satisfaction of the end consumer demand. Therefore, modelling system that allow to point these effects have to be used (Nuzzolo and Comi, [34]). Similarly, if we refer to tactical or operational planning horizons (e.g. updating of timetable of existing rail distribution system), the focus is mainly on distribution process, then changes in goods demand due to requests of end consumer can be neglected. Therefore, the simulation system of scenario effects should provide to analyse both passenger and goods vehicle flows because both of them can be influenced by such a city logistics measure implementation. Even if the demand models are the core of the simulation system because they allow the impact of any measures on actors' behaviours to be captured, few studies have been developed on the integration of shopping and restocking. Thus, this modelling aspect is pointed out in section 4 after that in section 3 the choice dimensions and actors which can act deliveries within urban area are identified and analysed showing because probabilistic-behavioural models have to be used.

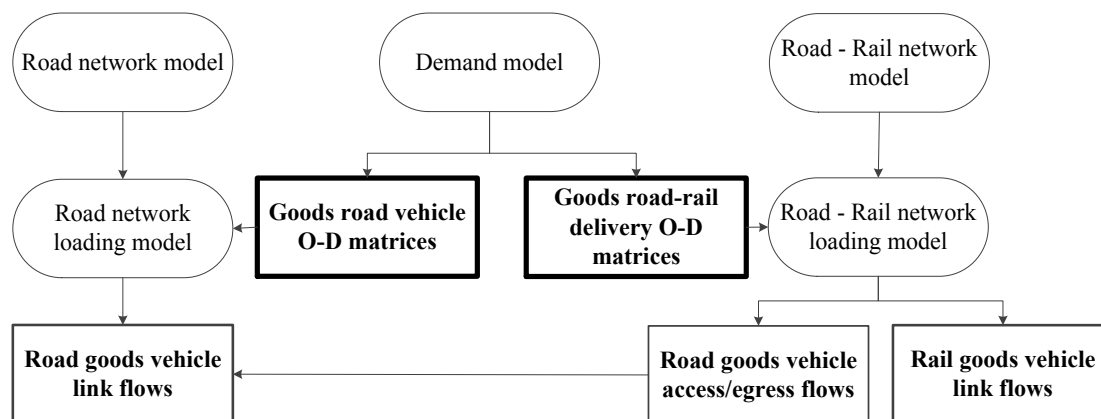

Fig. 1. Goods transport simulation: models and outputs
Rys. 1. Symulacja transport dóbr: modele i wyjścia

In this context, the paper seeks to: identify how the distribution scheme changes with the introduction of rail alternative and hence which is the most suitable demand models for the assessment of a rail-based urban goods transport system, also able to point out short and long term effects; to investigate which outputs should be provided by such models; to review the current state-of-the-art on urban goods demand modelling in order to point out the lack of current literature and hence to define the road ahead; to explore the modal choice dimensions and the decision makers involved; to identify which types of choice model can be used.

The paper starts from analysing the rail service in urban transport systems (section 2), the modal choice dimensions and the involved decision makers (section 3). Then, the focus is on the main developed demand models (section 4). As modal choice considering rail alternative has been rarely modelled, new demand models are proposed for simulating modal split and some indications on modelling specification are also given (section 5). Finally, some conclusions are reported in section 6.

2. URBAN GOODS RAIL SERVICE

The first step of the investigation of an urban goods rail service is to identify the components of urban goods transport, and its related functional structure taking into account that, in urban areas, goods transport is mainly related to the distribution of final products from producers, wholesalers and distribution centres to the businesses (e.g. shops, food-and-drink outlets, offices, firms). Therefore, the functional links currently operated by road vehicles and that could be substituted by rail have to be identified.

The rail goods system, considered in this paper, provides (Fig. 2) a connection between at least two rail terminals, where goods transshipment operations from road to railway and vice-versa are performed. One or more terminals (outer terminals) allow the connection between the medium-long distance road goods transport and the rail system; these connection terminals represent points in which all goods that have as final destination (or initial origin) the urban area will be carried from (or to). Other terminals (inner rail stop) are located within the urban area; they allow delivering to destinations within this area. Inner terminals located inside the urban area can also act as Transit Point or Nearby Delivery Area: goods arrives by rail and so it is delivered/picked by low emission light vehicles, adopting strategies providing at optimising delivery/picking tours (Fig. 3).

Even if the proposed rail service scheme can be applied in the whole urban goods distribution system, the main relationships that can be interested are the bold part of Fig. 2, that is the case in which the goods passes through a retailer or a food-and-drink outlet before arriving at the end consumer.

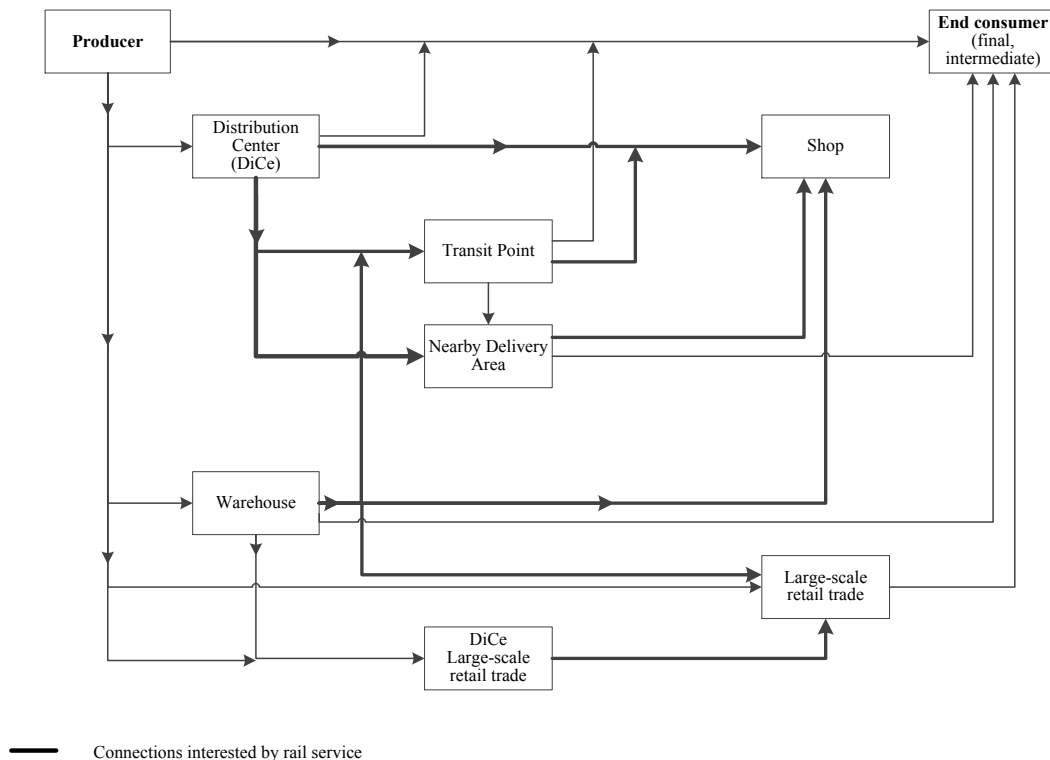

Fig. 2. Urban goods distribution scheme
Rys. 2. Schemat dystrybucji dóbr miejskich

The presence of railway transport as alternative to road transport modifies the structure of distribution moving from the one reported in Fig. 3 to that pictured in Fig. 4.

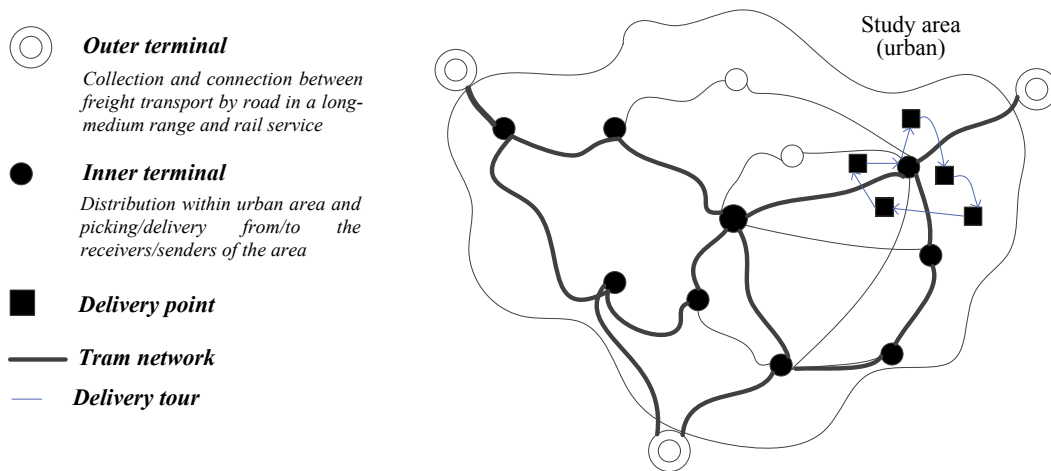

Fig. 3. Structure of an urban goods rail-based service

Rys. 3. Struktura dóbr miejskich transportowanych za pomocą usług kolejowych

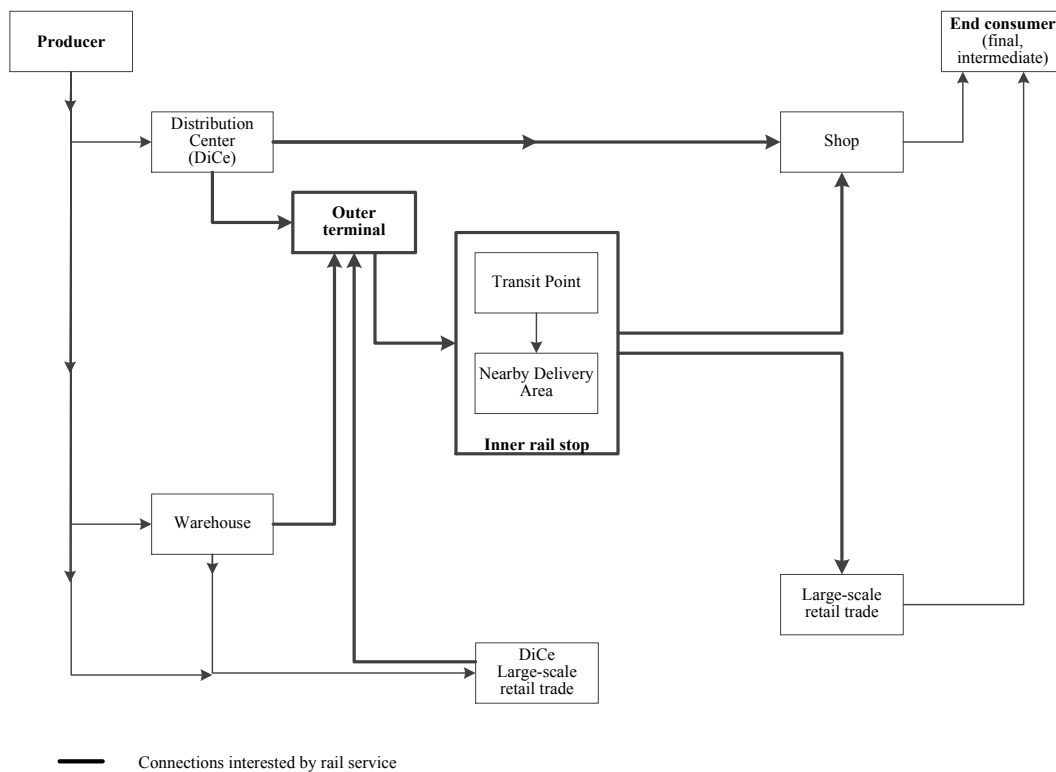

Fig. 4. Goods distribution scheme with rail services

Rys. 4. Schemat dystrybucji dóbr za pomocą usług kolejowych

3. CHOICE DIMENSIONS AND DECISION MAKERS INVOLVED IN MODE CHOICE

The urban goods transport is characterized by different decision makers, which act to move goods. In particular, the involved decision makers, which govern the delivery process, are the receivers (e.g. retailer) or the shippers (e.g. wholesaler) and they have to choose if operate on own account or by

using service offered by third parties (e.g. carrier). For examples, in Rome (Nuzzolo and Comi, [36]) the 27% of deliveries are governed at destination (i.e. the retailer decides all the stages for moving the goods from warehouses to shop), and the remaining 73% are governed by wholesalers or carriers. Data show also the effects of distance on the process. About the 67% of whole deliveries come from zones located within the municipality borders. In particular, when the retailer decides the restocking process, s/he does not prefer to go and bring goods far from his/her shop, because s/he generally prefers nearby warehouses. On the other hand, increasing the distance of restocking place the shares of retailers governing deliveries decreases. Table 2 gives the revealed shares according to the different goods types. We can see that:

- beverage, building materials, cloths, electronics, foodstuffs, home accessories, jewellery, pharmaceuticals and cosmetics, and stationery products are generally governed at origin and mainly come from a zone within the municipality; the restocking flows of these products represent the 81% of whole;
- flowers, household and hygiene products and music products (that represents the 6%) use to be governed at destination and mainly come from restocking zone within the municipality;
- the remaining products are governed with different shares at origin or at destination and come mainly from zones outside the municipality.

Table 3 hence reports the revealed shares according to the types of receivers, classifying them in three classes: ho.re.ca (i.e. hotel, restaurant and catering, food-and-drink outlets) activities, retailers, end consumers and other. The results show that, excluding ho.re.ca. activities, the other types of receivers suffer the choice made by the further actors of the transport process.

Subsequently, each decision makers can choose to use road or road-rail as transport mode, as reported in Fig. 5.

Table 2

Delivery government: shares revealed in the inner area of Rome according to goods type			
Goods type	at destination	at origin	Total
Beverage	21%	79%	100%
Building materials	9%	91%	100%
Cloths	17%	83%	100%
Electronics	0%	100%	100%
Flowers	95%	5%	100%
No-fresh foodstuffs	37%	63%	100%
Fresh foodstuffs	15%	85%	100%
Hardware	59%	41%	100%
Home accessories	29%	71%	100%
Household and hygiene products	77%	23%	100%
Jewellery	0%	100%	100%
Music products	63%	37%	100%
Pharmaceuticals, cosmetics	0%	100%	100%
Stationery products	9%	91%	100%
Other	47%	53%	100%
Average	27%	73%	100%

Therefore, goods modal choice with road and rail alternatives has two choice dimensions (type of service and mode) and three decision makers (i.e. retailers on own account, wholesalers on own account and carriers). Even if, in principle, the modal choice could be modelled alone, it is better to model together the two choice dimensions, as modal choice is strongly influenced by type of service choice, as detailed in the following.

Table 3

Delivery government:
shares revealed in the inner area of Rome according to type of receivers

Type of receiver	at destination	at origin	Total
Ho.re.ca	41%	59%	100%
Retailer	22%	78%	100%
End consumer	26%	74%	100%
Other	8%	92%	100%
Average	27%	73%	100%

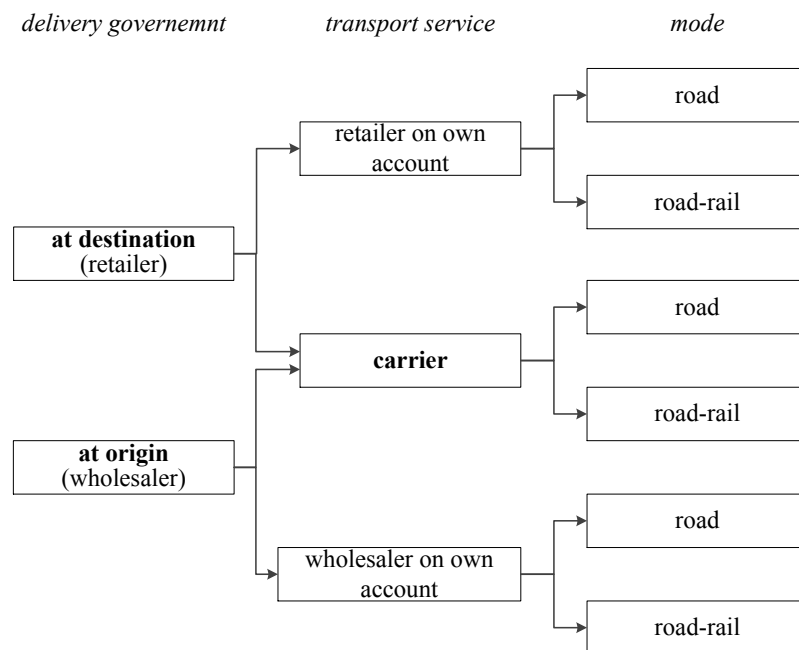

Fig. 5. Choice dimensions: delivery government, transport service type and mode
Rys. 5. Wybór wielkości: rząd dostawy, typ usługi transportowej oraz tryb

4. URBAN GOODS DEMAND MODELLING: A REVIEW

Urban goods flows are mainly generated by the requirement of end consumers to satisfy their needs for commodity and services. In fact, end-consumer choices in relation to retail outlet type (e.g. small, medium or large) and location impact upon goods distribution flows: the characteristics of the restocking process are strictly related to the type of retail business to be restocked in terms of delivery size, delivery frequency, goods vehicle type and so on. For example, delivery size and goods vehicle size tend to increase with the size of retail activities, while delivery frequency tends to decrease, with considerable effect on the total distance travelled by goods vehicles. Therefore, end-consumer choices among small, medium and large retail outlets affect restocking characteristics and the total goods vehicle distance travelled. In this context, we also require suitable methods that allow us to simulate shopping demand whilst taking into consideration the attitudes of end consumers (Nuzzolo and Comi, [34, 35]), in particular for long-term demand forecasting.

Although several urban goods demand models have been developed (see for a state-of-the-art Ambrosini et al. [2], Anand et al. [3], Gonzalez-Feliu and Routhier [22], Comi et al. [13]), few of them have proposed joint modelling frameworks able to point out that restocking flows are generated to satisfy end-consumer demand and restocking models consequently have to take account of end-consumer choices (Barone et al. [4], Crocco et al. [14], Gonzalez-Feliu et al. [23], Oppenheim [39], Russo and

Comi [43]; Comi and Nuzzolo [12]). Few studies have hence analysed shopping mobility as a component of goods mobility and considered that changes in shopping attitudes or actions impacting on purchasing behaviour of end consumers (e.g. location of shopping zone, transport mode to use for shopping) can also affect restocking mobility (Gonzalez-Feliu et al. [21], Miodonski and Kawamura [30]; Sanchez-Diaz et al. [45]). This shows that further work needs to be done in this field, especially when long-term scenarios have to be assessed.

Given the desirability of a joint modelling framework, this paper presents a modelling system, which takes into account some factors of end-consumer behaviour, such as the choice of retail outlet type, and links shopping and shop restocking mobility. It consists of two main steps (Fig. 6):

- shopping model sub-system; it allows to simulate end-consumer behaviour for shopping and to estimate quantity bought by end consumers in order to satisfy their needs, and hence to identify the goods flows attracted by each traffic zone;
- restocking model sub-system; given the quantity attracted by each traffic zone, it allows to estimate the restocking quantity origin-destination (O-D) matrices characterized by goods types and type of vehicle used.

The shopping model sub-system allows to point out the effects arising from implementation of medium/long-term actions on the location of retail outlets and places of residence, and due to changes in the characteristics of the population (e.g. demographic and socio-economic changes).

The restocking sub-system includes models for the simulation of the goods distribution process from the freight centres to the retail zone, and can be used to determine the effects arising from implementation of actions on the location of logistic establishments (e.g. warehouses, distribution centres) and on measures that can modify the use of transport service type (i.e. incentives to switch towards third parties and to use rail), the vehicle type, the shipment size and the delivery time (i.e. time windows)

Currently, this model system does not include a model of intra-urban freight modal-split. In the literature, models developed for this purpose refer mainly to intercity transport (de Jong [16]), as for the urban context, the only available transport mode usually is road transport; therefore, the mode choice is rarely modelled. The modelling system presented above is a multi-stage model. It considers a discrete choice approach for each decisional level and allows to include the modal split stage. The advancement of the actual restocking model sub-system, in order to take into account the rail service, is presented in the next section 5.

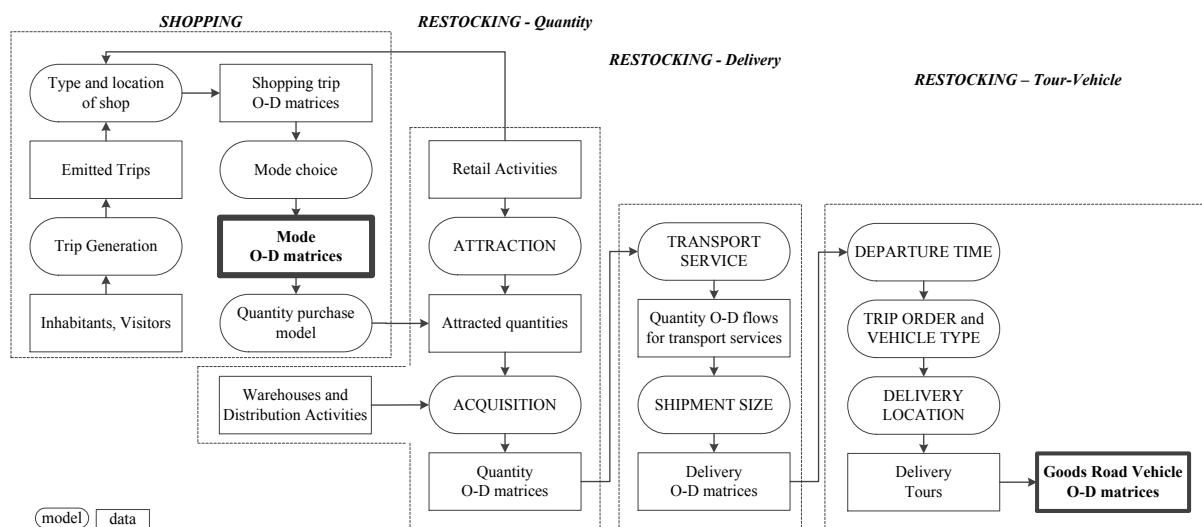

Fig. 6. Goods O-D estimation modelling (Nuzzolo and Comi [34])

Rys. 6. Modelowanie oszacowania towarów O-D (Nuzzolo and Comi [34])

5. THE PROPOSED APPROACH IN TRANSPORT SERVICE AND MODE CHOICE MODELLING

The restocking sub-system model of the general demand model system reported in Fig. 6 can be updated, introducing transport service and modal choice models, as pictured in Fig. 7.

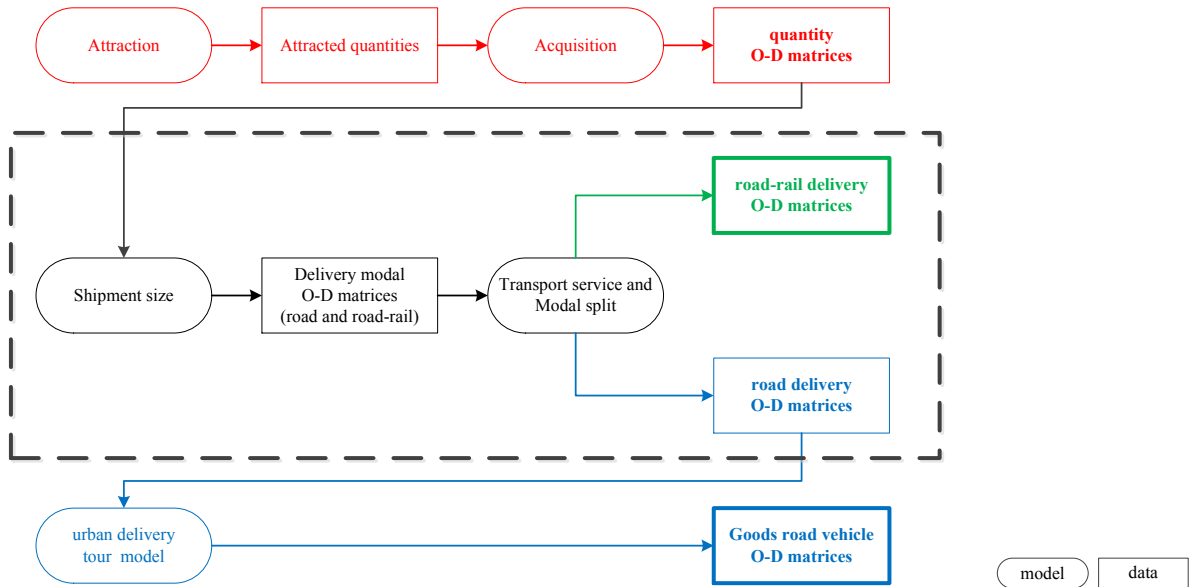

Fig. 7. Advancement in the existing modelling structure
Rys. 7. Postęp w istniejącej strukturze modelowania

According to Fig. 5, transport service and modal choice models have to be developed with different model specification, in relation to who the decision maker is:

- retailer on own account;
- wholesaler on own account;
- carrier.

Referring to retailer and wholesaler on own account, within the random utility theory approach (Ben Akiva and Lerman, [6] and Cascetta [10]), the nested modelling can be used, in order to take into account expected correlation among alternative. Therefore, the probability of mode m , $p[m/od]$ can be expressed as follows:

$$p[m/od] = p[r/od] \cdot p[m/rod] = \frac{\exp(V_r + \delta_r Y_r)}{\sum_{r'} \exp(V_{r'} + \delta_{r'} Y_{r'})} \cdot \frac{\exp(V_{m/r})}{\sum_{m'} \exp(V_{m'/r})}, \quad (1)$$

where: $p[r/od]$ is the probability to be restocked by transport service r (i.e. retailer or wholesaler on own account, or carrier); $p[m/rod]$ is the probability to use mode m (i.e. road or road-rail) having chosen transport service r (i.e. road or road-rail); V_r is the systematic utility for the choice alternative r ; Y_r is the logsum variable of group r obtained with the alternative specific systematic utilities $V_{m/r}$; $V_{m/r}$ is the systematic utility of the choice alternative m belonging to the group r .

Other different and more sophisticate random utility models able to simulate the above choices jointly are recalled in section 5.3.

For example, if the choice performed by carrier is to point out, the choice process leads back to mode choice. Then, the probability $p[m/od, carrier]$ to use mode m (i.e. road or road-rail) having previously chosen transport service “carrier” can be expressed as follows:

$$p[m / carrier, od] = \frac{\exp(V_{m/carrier})}{\sum_{m'} \exp(V_{m'/carrier})}, \quad (2)$$

where $V_{m/carrier}$ is the systematic utility of carrier for the alternative m .

As detailed in previous section, in the literature, models developed for this purpose refer mainly to intercity transport. In urban context, while few models for transport service choice were developed, mode choice with rail alternative is rarely, if ever, modelled. Only few examples of statistical-descriptive models based on empirical data have been proposed (see Table 1). Then, in the following sub-sections, before the current models for transport service type are recalled, then some examples of utility functions for transport service and modal choice models are described.

5.1. The current transport service models

From the data collected in some Italian cities, different shares according to transport service type were revealed in relation to goods types. Table 4 recalls the shares revealed in Rome. From some retailer interview data (Comi [12], Nuzzolo et al. [37]), a binomial logit model was calibrated with two types of transport service: retailers on own account (c_{oa}) and other transport service types (c_{ip}). The calibration was performed by Maximum Likelihood (ML) method and the model capability to reproduce the choice made by sample was measured by ρ^2 statistic.

Table 4

Transport service type:
shares revealed in the inner area of Rome (Nuzzolo and Comi [35])

Goods type	Retail on own account	Wholesaler on own account	Carrier	Total
Foodstuffs	15%	61%	24%	100%
Home Accessories	31%	46%	23%	100%
Stationery	11%	65%	24%	100%
Clothing	11%	42%	47%	100%
Building Materials	6%	40%	54%	100%
Household and personal hygiene	9%	22%	69%	100%
Other goods	28%	21%	51%	100%
Total (average share)	20%	49%	31%	100%

Using data from Rome interview data, the systematic functions of the two identified transport service alternatives were expressed as follows:

$$\begin{aligned} V_{c_{oa}} &= ASA_{c_{oa}} \\ V_{c_{ip}} &= \beta_1 \cdot PROD + \beta_2 \cdot CD + \beta_3 \cdot WH + \beta_4 \cdot DPT + \beta_5 \cdot EM + \beta_6 \cdot ADY + \beta_7 \cdot q + \beta_8 \cdot TIME \end{aligned} \quad (3)$$

where: $V_{c_{oa}}$ is the systematic utility for transport *on own account*, $V_{c_{ip}}$ is the systematic utility for transport *by carrier* or *wholesaler on own account*, $PROD$ is a dummy variable equal to 1 if the restocked goods arrives from a *producer*, CD is a dummy variable equal to 1 if the restocked goods arrives from a *distribution center*, WH is a dummy variable equal to 1 if the restocked goods arrives from a *wholesaler*, DPT is a dummy variable equal to 1 if the attractor owns a store, EM is the number of employees at shop to be restocked, ADY is a dummy variable equal to 1 if the deliveries are received all days, q is the average *shipment size*, expressed in tons; $TIME$ is the time spent for delivering.

As point out some studies focusing on this field (Danielis et al. [15]), the type of services is also strictly dependent to the type of attractor. Table 4 reports the sets of parameters estimated for the different types of attractors. As revealed by surveys, we can see that the probability of being restocked

by other transport service types rises if freight comes from a distribution centre. This probability also increases with the number of employees at the shop and with shipment size. Activities related to foodstuffs tend to be restocked more than others from distribution centre and prefer carrier's service. The probability to be restocked by carrier increases with availability of depots and weight changes according to attractor type. These results are quite useful in order to develop new modal choice models, as reported in the next sub-section 5.2.

Table 5

Transport service type: calibration results in Rome											
Attributes	Bar		Hairdresser Hotel				Restaurant and foodstuff retailer		Other		
	value	<i>t-st</i>	value	<i>t-st</i>	value	<i>t-st</i>	value	<i>t-st</i>	value	<i>t-st</i>	
<i>carrier or wholesaler on own account (c_{tp})</i>											
from producer (<i>PROD</i>)	0/1	1.90	2.2	1.76	1.9	2.32	3.4	3.03	4.4	0.95	1.7
from distribution centre (<i>CD</i>)	0/1	2.37	3.4	2.92	3.0	2.4	2.9	3.4	4.9	1.44	1.9
from wholesaler (<i>WH</i>)	0/1	1.89	2.5	1.51	1.2	1.21	1.3	2.28	1.6	0.91	1.9
presence of depot (<i>DPT</i>)	0/1					2.87	4.2	0.46	3.8	0.55	1.5
number of employees (<i>EM</i>)						0.03	2.0	0.05	1.0	0.25	1.4
deliveries received all day (<i>ADY</i>)	0/1	-0.89	-1.4			-0.87	-1.4	-0.27	-1.5		
quantity per delivery (<i>q</i>)	tons	0.40	1.4							0.60	1.5
minutes spent for delivery (<i>TIME</i>)	min			0.012	1.9			0.005	1.4		
<i>receiver on own account (c_{oa})</i>											
ASA	0/1	0.50	1.8	1.04	1.2	1.21	2.1	2.93	3.4	1.36	1.8
ρ^2		0.29		0.22		0.31		0.23		0.28	

On the other hand, from data collected in a town near Rome (i.e. Capranica), about the 80% of deliveries are governed at origin and the 75% of them use to transport on own account. The collected data allowed to estimate different models for deliveries governed at origin and at destination. The systematic utility has been expressed as linear function of the following attributes:

- *TM* is a dummy variable equal to 1 if the delivery happens after 11 am, 0 otherwise,
- *RS* is the sale surface, expressed in m²;
- *q* is the average shipment size, expressed in tons.
- *ORI* is the distance from restocking zone, expressed in km;
- *CUST* is the number of customers daily served.

Table 6 reports the obtained results. We note that, as expected, the retailers on own account generally go to bring goods in the morning and the bigger ones prefer third party services, while senders for restocking large and far activities usually use third party services.

Table 6

Transport service type:
calibration results in a town

Attributes	at destination		at origin	
	value	<i>t-st</i>	value	<i>t-st</i>
<i>carrier or wholesaler on own account (c_{tp})</i>				
morning deliveries (<i>TM</i>)	0/1	4.36	1.9	
sale surface (<i>RS</i>)	m ²	3.95E-3	2.4	
quantity per delivery (<i>q</i>)	tons	2.84	1.4	0.42 3.3
distance from restocking zone (<i>ORI</i>)	km			3.98E-3 2.6
number of customers (<i>CUST</i>)				1.68E-3 2.3
<i>receiver on own account (c_{oa})</i>				
ASA	0/1	6.33	2.1	2.02 4.1
ρ^2		0.39		0.22

5.2. Transport service and modal choice utility functions

On the bases of the previous analyses and according to each decision maker, the systematic utility for transport service and mode choice alternative should be expressed in function of the following attributes:

- type of commodity chain
 - goods type (e.g. foodstuffs, clothing, home accessories),
 - characteristics of attractor type,
 - characteristics of shipper,
 - characteristics of delivery (e.g. shipment size, delivery time),
 - requirements of goods (e.g. package, cool chain),
 - time constraints;
- characteristics of mode alternative
 - access/egress travel times and costs,
 - travel time,
 - travel cost,
 - availability of storage at inner rail stop.
 - availability of tracing service.

Then, an example of systematic utility function for the alternative *transport service r* (V_r) is the following:

$$V_r = \beta_1 \cdot X_{attr} + \beta_2 \cdot X_{emp} + \beta_3 \cdot X_{type} + \beta_4 \cdot q + \beta_5 \cdot X_{const} + \beta_6 \cdot X_{cool} + \beta_7 \cdot X_{tccar} + \beta_8 \cdot X_{tcar} + \beta_9 \cdot X_{warehouse} + \beta_{10} \cdot X_{tracing} + \beta_{11} \cdot Y_r \quad (4)$$

where: X_{attr} is a dummy variable equal to 1 if the attractor is a food-and-drink outlet (e.g. bar, restaurant), 0 otherwise; X_{emp} is the number of employees of attractors; X_{type} is a dummy variable equal to 1 if goods is foodstuffs, 0 otherwise; q is the shipment size; X_{const} is a dummy variable equal to 1 if the deliveries has to be performed before 10 am, 0 otherwise; X_{cool} is a dummy variable equal to 1 for cool deliveries, 0 otherwise; X_{tccar} is a travel time by transport service *carrier*; X_{tcar} is a travel cost by transport service *carrier*; $X_{warehouse}$ is a dummy variable equal to 1 if storage service is provided by transport service *carrier*, 0 otherwise; $X_{tracing}$ is a dummy variable equal to 1 if tracing service is provided by transport service *carrier*, 0 otherwise; Y_r is the logsum variable of group r .

Referring to modal choice, an example of systematic utility function for alternative mode m ($V_{m/r}$) is the following:

$$V_m = \beta_{21} \cdot X_{ttae} + \beta_{22} \cdot X_{tcae} + \beta_{23} \cdot X_{ttc} + \beta_{24} \cdot X_{warehouse_rail} + \beta_{25} \cdot X_{racing_rail} + \beta_{26} \cdot X_{aveh} \quad (5)$$

where: X_{itae} is the travel time for access/egress; X_{iccae} is the travel cost for access/egress; X_{itc} is the travel cost on mode m ; $X_{warehouse_rail}$ is a dummy variable equal to 1 if storage service is provided by rail service, 0 otherwise; X_{racing_rail} is a dummy variable equal to 1 if tracing service is provided by rail service, 0 otherwise; X_{aveh} is the number of road vehicles owned by decision maker.

We have to note that different ranges of some attributes can be considered in the utility functions in order to deal the non-linear effects (Marcucci and Gatta [27]).

Of course, during the model parameter estimation procedure, we have to find the best functional form and the best variables (combination of the above attributes), according to the best “statistical quality” of the model, and taking into account the application requirements.

5.3. Alternative Random Utility models

A highly flexible model that can approximate any random utility model is the Mixed Logit (Hensher [24], McFadden and Train [29]). It obviates the main limitations of standard logit by allowing to deal properly:

- the preference heterogeneity across decision makers or groups (Hensher [24], Marcucci and Gatta [26]),
- the correlation among perceived utilities of the choice alternatives (Train [48]).

At it is well known, in the Mixed Logit (ML) models it is assumed that the vectors of parameters θ are random variables whit probability density function $f(\theta)$. The probability $p^i[j]$ of Mixed Logit (ML) model, that the decision maker i chooses the alternative j , is the integral of standard logit probabilities over a probability density function of parameters (Train [48]):

$$p^i[j] = \int L_j^i(\theta) \cdot f(\theta) \cdot d\theta \quad (6)$$

where $L_j^i(\theta)$ is the logit probability, evaluated at a set of parameters θ and their density function, $f(\theta)$. If $f(\theta)$ degenerates at fixed parameters β (i.e. it equals one for $\theta = \beta$ and zero for $\theta \neq \beta$), the above choice probability becomes the simple multinomial logit model.

If θ are discrete random variables (i.e. if θ takes only M values, labelled β_1, \dots, β_M), then ML becomes the *latent class* model. This model is useful when there are M distinct segments in the population, each with own choice behaviour (Train [48]). If $M = 1$, then the ML becomes the multinomial logit model.

The ML model can assume the similar specification of standard multinomial logit except that θ varies over decision makers rather than being fixed. In this random coefficients structure, the marginal utility parameters are different for each sampled individual (decision maker), but do not vary across choice situations; this last assumption may be relaxed if choice situations are significantly separated along time. On the other hand, the correlation among the perceived utilities of the choice alternatives can be taken into account specifying a correlation structure of the random residuals (Ortuzar and Willumsen [40], Train [48]). In this case, the perceived utility function of alternative is characterised by an error term with two elements: one that allows the multinomial probability to be obtained and one with a probability density function that can be chosen by the modeller, depending on the phenomenon to be reproduced.

The two mixed logit specifications are formally equivalent. However, although formally equivalent, the manner in which the modeller looks at the phenomenon under study affects the model specification. For example, if the main interest is to represent appropriate substitution patterns through a random coefficient specification, the emphasis will be placed on specifying variables that can induce correlation, not necessarily considering tastes variations.

6. CONCLUSIONS

The congestion in urban areas, the restrictions applied for environmental issues, and the reduction of accessibility of particular urban centres, have forwarded researchers to investigate solutions to define modal alternatives to road transport for goods shipments.

The key role in this analysis is played by the goods demand modelling system that was specified and calibrated in order to obtain the potential goods demand attracted by the new distribution system based on rail services. The system has to point the behavioural mechanism associated to the introduction of specific measures and to detail the analysis of service competitiveness. The literature review shows a lack in mode choice modelling. In fact, the mode choice with rail alternative in an urban goods context has been rarely, if ever, modelled. Therefore, a choice modelling structure has been proposed, that includes the choice of the type of service and the mode transport on the basis of previous analysis and model at urban goods context. Therefore, paper presented some methodological aspects for modelling the demand for rail in an urban context.

On the other hand, as emerged from the literature review, rail-based goods distribution system could be consistent, but it needs an in-depth feasible analysis because an increasing of direct cost supported by users could occur. Therefore, public authority has to promoting urban modal shift, by creating the initial conditions such as a good location and good access, including by road, to rail terminals.

References

1. Alessandrini, A. & Delle Site, P. & Filippi, F. & Salucci, M. V. Using rail to make urban freight distribution more sustainable. *European Transport*. 2012. Vol. 50. Paper 5. Trieste, Italy.
2. Ambrosini, C. & Meimbresse, B. & Routhier, J. L. & Sonntag, H. Urban freight modeling: a review. *Innovations for City Logistics*. 2008. P. 197-212. Nova Science Publishing.
3. Anand, N. & Quak, H., van Duin, R. & Tavasszy, L. City logistics modeling efforts: Trends and gaps - A review. *Procedia – Social and Behavioral Sciences*. 2012. Vol. 39. P. 101-115. Elsevier Ltd.
4. Barone, V. & Crocco, F. & Mongelli, D. W. Freight Transport Demand Models for Applications in Urban Areas. *Applied Mechanics and Materials*. 2014. Vol. 442. P. 634-644.
5. Behrends, S. *Urban freight transport sustainability. The interaction of urban freight and intermodal transport*. PhD Thesis. Chalmers University of Technology. Sweden. 2011.
6. Ben-Akiva, M. & Lerman, S.R. *Discrete Choice Analysis: Theory and Application to Travel Demand*. MIT Press. USA. 1985.
7. BESTUFS. Rail based transport: A disappearing opportunity or a challenge for urban areas? In: *Fifth Bestufs Workshop*. Dresden, Germany. 2001.
8. Browne, M. & Allen, J. & Nemoto, T. & Patier, D. & Visser, J. Reducing social and environmental impacts of urban freight transport: A review of some major cities. *Procedia - Social and Behavioral Sciences*. 2012. Vol. 39. P. 19-33.
9. Browne, M. & Woodburn, A. & Piotrowska, M. & Allen, J. A review of rail freight initiatives in the urban supply chain. In: *RGS-IBG Annual Conference*. 2013.
10. Cascetta, E. *Transportation Systems Analysis: Models and Applications*. Springer. 2009.
11. Comi, A. A system of models for simulating shop restocking. *Environment, land use and transportation systems – selected papers*. Cappelli, A. & Libardo, A. & Nocera, S. (eds), Franco Angeli. Milano. 2013. P. 237-249.
12. Comi, A. & Nuzzolo, A. Simulating Urban Freight Flows with Combined Shopping and Restocking Demand Models. *Procedia – Social and Behavioral Sciences*. 2014. Vol. 125. P. 239-250. Elsevier. DOI: 10.1016/j.sbspro.2014.01.1455.
13. Comi, A. & Donnelly, R. & Russo, F. Urban freight models. *Modelling Freight Transport*. Tavasszy, L. & De Jong, J. (eds), chapter 8. 2014. P. 163-200. Elsevier. DOI: 10.1016/B978-0-12-410400-6.00008-2.
14. Crocco, F. & De Marco, S. & Iaquina, P. & Mongelli, D.W. Freight transport in urban areas: an integrated system of models to simulate freight demand and passengers demand for purchase trips. *International Journal of Mathematical models and methods in applied sciences*. 2010. Vol. 4(4). P. 265-273.

15. Danielis, R. & Rotaris, L. & Marcucci, E. Urban freight policies and distribution channels: a discussion based on evidence from Italian cities. *European Transport. Trasporti Europei*. 2010. Vol. 46. P. 114-146.
16. de Jong, G. Mode Choice Models. In: *Modelling Freight Transport*. Tavasszy, L. & De Jong, J. (eds), chapter 6. 2014. P. 117-141. Elsevier. DOI: 10.1016/B978-0-12-410400-6.00006-9.
17. De Langhe, K. Developing a social cost-benefit framework for rail, based urban freight solutions. In: *Proceedings of IX City Logistics Conference*. Tenerife, Spain. 2015.
18. Dizian, D. & Taniguchi, E. & Dabanc, L. Urban logistics by rail and waterways in France and Japan. *Procedia – Social and Behavioral Science*. 2014. Vol. 125. P. 159 -170.
19. Genta, S. & Marangon, F. & Messina, M. G. e Valentini, M. P. TADIRAM project: organizational and technical proposals for freight distribution in the sustainable city. In: *Proceedings of European Transport Conference*. Strasbourg, France. 2006.
20. Gonzalez-Feliu, J. Costs and benefits of railway urban logistics: a prospective social cost benefit analysis. Hal archives-outvertes. 2014.
21. Gonzalez-Feliu, J. & Ambrosini, C. & Pluvinet, P. & Toilier, F. & Routhier, J. L. A simulation framework for evaluating the impacts of urban goods transport in terms of road occupancy. In: *Journal of Computational Science*. 2012. Vol. 3(4). P. 206-215. Elsevier.
22. Gonzalez-Feliu, J. & Routhier J. Modeling urban goods movement: How to be oriented with so many approaches? *Procedia – Social and Behavioral Sciences*. 2012. Vol. 39. P. 89-100.
23. Gonzalez-Feliu, J. & Toilier, F. & Routhier, J.L. End consumer goods movement generation in French medium urban areas. *Procedia - Social and Behavioral Sciences*. 2010. Vol. 2(3). P. 6189-6204.
24. Hensher, D.A. & Green, W.H. The Mixed Logit model: The state of practice. *Transportation*. 2003. Vol. 30(2). Springer.
25. Lange. Cargo Tram in Dresden. *Paper presented at the 5th BESTUFS Workshop*. Dresden, Germany. 2001.
26. Marcucci, E. & Gatta, V. Intra-agent heterogeneity in urban freight distribution: the case of own-account operators. *International Journal of Transport Economics*. 2013. Vol. XL/2. P. 267-286.
27. Marcucci, E. & Gatta, V. Behavioral modeling of urban freight transport. Testing non-linear policy effects for retailers. *Sustainable Urban Logistics: Concepts, Methods and Information Systems*. 2014. P. 227-243. Gonzalez-Feliu J. & et al. (eds.). Springer.
28. Marinov, M. & Giubilei, F. & Gerhardt, M. & Ozkan, T. & Stergiou, E. & Papadopol, M. & Cabecinha, L. Urban freight movement by rail. In: *Journal of Transport Literature*. 2013. Vol. 7(3). P. 87-116.
29. McFadden, D. & K. Train. Mixed MNL models of discrete response. *Journal of Applied Econometrics*. 2000. Vol. 15. P. 447-470.
30. Miodonski, D. & Kawamura, K. Effects of Built Environment on Freight Consumption. *Procedia - Social and Behavioral Sciences*. 2012. Vol. 39. P. 74-88. Taniguchi E. & Thompson R.G. (eds.). Elsevier Ltd.
31. Mortimer, P. *Urban freight and the use of rail*. Bestufs UK paper. 2008. Available at: www.bestufs.net.
32. Motraghi, A. & Morinov, M. V. Analysis of urban freight by rail using event based simulation. *Simulation Modelling Practice and Theory*. 2012. Vol. 25. P. 73-89. Elsevier Ltd.
33. Nuzzolo, A. & Comi, A. Tactical and operational city logistics: freight vehicle flow modeling. *Freight Transport Modelling*. 2013. Moshe Ben Akiva. Hilde Meersman & Eddy Van de Voorde (eds.). Emerald Group Publishing Limited. Chapter 21. P. 433-451.
34. Nuzzolo, A. & Comi, A. A system of models to forecast the effects of demographic changes on urban shop restocking. *Research in Transportation Business & Management*. 2014. Vol. 11. P. 242-251. Elsevier. DOI: 10.1016/j.rtbm.2014.03.001.
35. Nuzzolo, A. & Comi, A. Urban freight demand forecasting: a mixed quantity/delivery/vehicle-based model. *Transportation Research Part E*. 2014. Vol. 65. P. 84-98. Elsevier Ltd. DOI: 10.1016/j.tre.2013.12.014.

36. Nuzzolo, A. & Comi, A. Urban Freight Transport Policies in Rome: Lessons Learned and the Road Ahead. *Journal of Urbanism: International Research on Placemaking and Urban Sustainability*. 2015. Vol. 8(2). P. 133-147. Taylor & Francis. DOI: 10.1080/17549175.2014.884976.
37. Nuzzolo, A. & Comi, A. & Ibeas, A. & Moura, J.L. Urban Freight Transport and City Logistics Policies: Indications from Rome, Barcelona and Santander. *International Journal of Sustainable Transportation*. 2015. Francis & Taylor. DOI: 10.1080/15568318.2015.1014778.
38. Nuzzolo, A. & Crisalli, U. & Comi, A. Metropolitan freight distribution by railways. *Innovations in City Logistics*. 2008. Taniguchi E. & Thompson R.G. (eds.). Nova Science Publishers. Hauppauge NY, U.S.A.
39. Oppenheim, N. *Urban Travel Demand Modeling*. John Wiley & Son. New York, U.S.A. 1994.
40. Ortuzar, J. de D. & Willumsen, L.G. *Modelling transport*. John Wiley & Sons. Ltd. 2011.
41. Robinson, M & Mortimer, P. Urban freight and rail: the state of the art. *Logistics & Transport Focus*. 2004. P. 46-51. Available at: www.iolt.org.uk.
42. Robinson, M & Mortimer, P. Rail in urban freight: what future, if any? *Logistics & Transport Focus*. 2004. Available at: www.iolt.org.uk.
43. Russo, F. & Comi, A. A modelling system to simulate goods movements at an urban scale. *Transportation*. 2010. Vol. 37(6). P 987-1009. Springer Science+Business Media. LLC. DOI: 10.1007/s11116-010-9276-y.
44. Russo, F. & Comi, A. Measures for sustainable freight transportation at urban scale: expected goals and tested results in Europe. *Journal of Urban Planning and Development*. 2011. Vol. 137(2). P. 142-152. American Society of Civil Engineers (ASCE). DOI: 10.1061/(ASCE)UP.1943-5444.0000052.
45. Sanchez-Diaz, I. & Holguin-Veras, J. & Wang, C. Assessing the role of land-use, network characteristics and spatial effects on freight trip attraction. In: *Proceedings of the 92nd TRB Annual Meeting*. 2013. Transportation Research Board of the National Academies. Washington DC, USA.
46. Sladkowsky, A. & Dantas, R. & Micu, R. & Sekar, G. & Arena, A. & Singhanian, V. Urban freight distribution: council warehousing & freight by rail. *Transport Problems*. 2014. Vol. 9. Special Edition. P. 29-43.
47. Taniguchi, E. & Thompson, R. G. Proceedings of the Eighth International Conference on City Logistics. *Procedia - Social and Behavioral Sciences*. 2014. Vol. 125. P. 1-518.
48. Train, K. *Discrete Choice Methods with Simulation*. Cambridge University Press. Berkeley, USA. 2009.
49. van Binsbergen, A & Visser, J. *Innovation Steps Towards Efficient Goods Distribution Systems for Urban Areas*. TRAIL Thesis Series nr. T2001/5. The Netherlands TRAIL Research School. 2001.
50. Wiegmans, B. W. & Visser, J. & Konings, R. & Pielage, B.J.A. Review of underground logistic systems in the Netherlands: an ex-post evaluation of barriers, enablers and spin-offs. *European Transport*. 2010. Vol. 45. P. 1-16.

Received 12.07.2014; accepted in revised form 01.12.2015